

MaxMotion

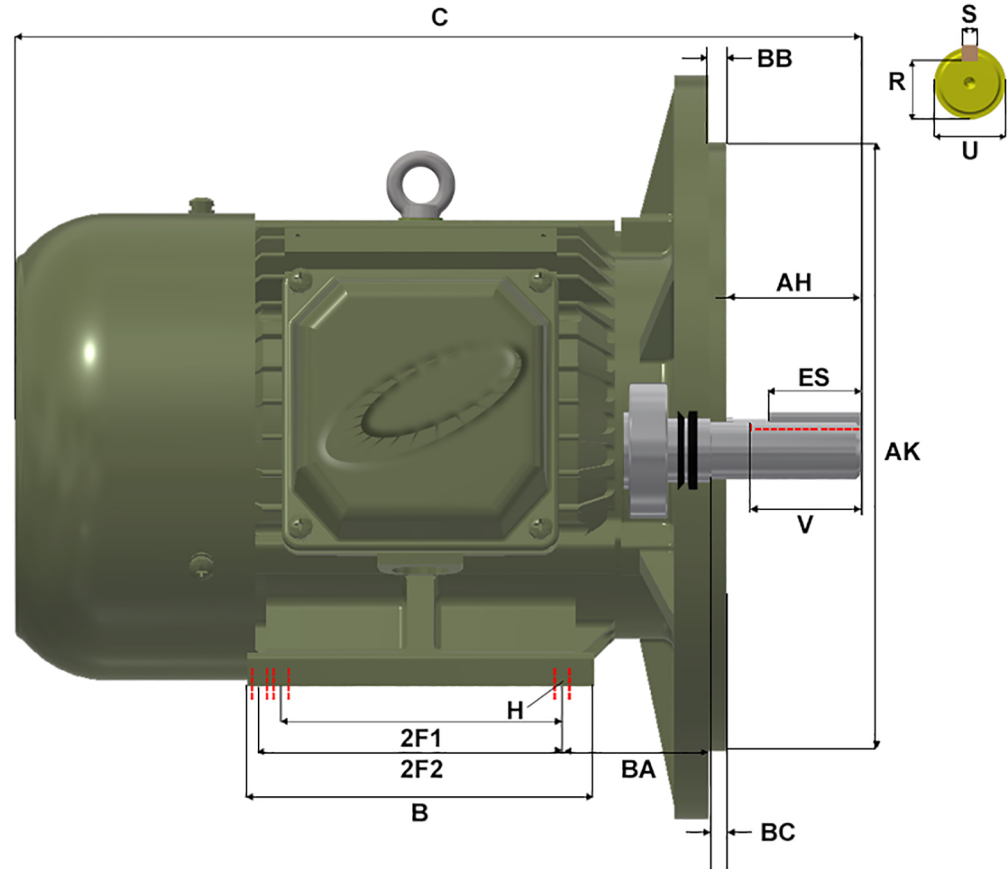
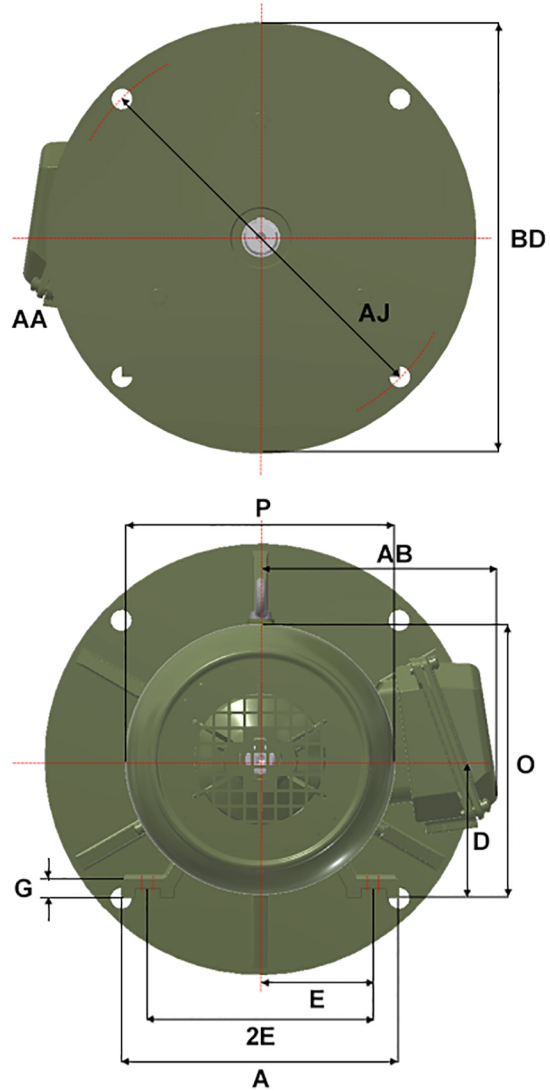

Version: 2WTI		Revised: 08-10-2019		HP	RPM	FRAME	ENCLOSURE	MPP/MQP-62D					
Customer is responsible in determining that MEP product will fit/perform suitably in the intended application				50	1800	326TD	TEFC						
A	B	C	D	E	2E	2F1	2F2	G	H	O	P	R	S
15.50	14.70	31.30	8.00	6.25	12.50	10.50	12.00	1.00	6 * 0.66	15.90	15.70	1.845	0.500
T	U	V	AA	AB	AH	AJ	AK	BA	BB	BC	BD	ES	
2.60	2.13	5.00	2 NPT	12.30	5.25	16.00	14.00	5.25	0.25	0.00	18.00	3.91	